

IT-12

DVB-S/S2 SIGNAL ANALYZER

OPERATING MANUAL



▶ PLANAR

30.01.2012

TABLE OF CONTENTS

1. GENERAL INFORMATION.....	5
1.1. Introduction.....	5
1.2. Safety precaution.....	5
2. GENERAL PRESCRIPTION AND PRINCIPLE OF OPERATION	5
2.1. Function.....	5
2.2. Environment Conditions.....	6
2.3. Package Contents	6
2.4. Specifications.....	7
2.5. Design and Operation Overview	8
2.5.1. Principle of Operation.....	8
2.5.2. Block Diagram.....	8
2.5.3. Component Arrangement.....	9
3. PREPARATION FOR OPERATION.....	9
4. OPERATION PROCEDURE.....	9
4.1. Controls and Indicators.....	9
4.2. Operation Starting.....	9
4.3. Main Menu	10
4.4. Preparation for Measurements	10
4.5. Frequency Setting Modes	11
4.5.1. General Information	11
4.5.2. Quick LNB Setting.....	11
4.5.3. LNB Profiles	12
4.5.4. Satellite Parameter Tables.....	14
4.5.5. DiSEqC Commander Mode.....	16
4.6. Measurement Procedure	17
4.6.1. General information.....	17
4.6.2. Measurement Parameter Setting Mode.....	18
4.6.3. Single LNB Dish Alignment Mode	18
4.6.4. Dual LNB Dish Alignment Mode.....	20
4.6.5. Spectrum Analyzer Mode.....	21
4.6.6. Dish Alignment to Reception Quality Parameters Mode.....	22
4.6.7. Reception Quality Parameter Table Mode	23
4.6.8. Recommended Procedure for Satellite Dish Alignment	26
4.7. Data Logger Function	27
4.7.1. General Information	27
4.7.2. Table of Reception Quality Parameters Reports	27
4.8. Self-Test Mode	28
4.8.1. General Information	28
4.8.2. Temperature.....	28
4.8.3. Battery Condition.....	29
4.8.4. Internal Devices Check	29
4.8.5. Memory Resources Check.....	29
4.9. User Interface Setting	29
4.9.1. General Information	29
4.9.2. LCD Contrast Setting	30
4.9.3. Displaying Mode Selection	30
4.9.4. Language Selection	30
4.9.5. Audio Indication Mode.....	30
4.9.6. Key Pressing Sound Selection	30

4.9.7. Sound Level Setting	30
4.9.8. Startup Mode Selection	30
4.10. Identification Data Readout.....	30
4.11. Operation Controlled by PC	31
4.11.1. General Information.....	31
4.11.2. PC Configuration Requirements.....	31
4.11.3. Software Installation	31
4.11.4. USB Port Driver Installation.....	32
4.11.5. Starting the Program	32
4.12. Firmware updating	32
4.13. Battery Operation.....	34
4.14. Magnetic Compass Mode	35
4.14.1. Magnetic Compass Calibration	36
4.14.2. Recommended Procedure of Magnetic Compass.....	36
5. MAINTENANCE.....	37
6. TROUBLESHOOTING.....	37
7. STORAGE	37
8. TRANSPORTATION.....	37
9. LABELING	38
10. WARRANTY INFORMATION	38

1. GENERAL INFORMATION

1.1. Introduction

This Operating Manual is intended for introducing the design, functions, and basic instructions related to operation, servicing and transportation of the DVB-S/S2 Signal Analyzer (Analyzer).

The IT-12 DVB-S/S2 Signal Analyzer is designed for control and alignment of reception systems for digital or analog satellite television and broadcasting.

The Analyzer can be used both in laboratory, powered by an external power source, and in field, powered by batteries.

The reliability of the IT-12 is ensured by fulfillment of regular maintenance procedures. These procedures and their intervals are described in section 5.

In this manual the following abbreviations are used:

- ADC -Analog Digital Converter;
- LCD -Liquid Crystal Display;
- DL -Data Logger;
- IF -Intermediate Frequency;
- PC -Personal Computer;
- QPSK -Quadrature Phase Shift Keying;
- 8PSK - 8 Phase Shift Keying;
- LDPC -Low-density parity-check code;
- BCH -Parameterised error-correcting code;
- LNB -Low Noise Block;
- DiSEqC -Digital Satellite Equipment Control;
- MPEG -Motion Pictures Expert Group;
- AGC -Automatic Gain Control;
- ETSI -European Telecommunications Standards Institute;
- DVB -Digital Video Broadcasting.

1.2. Safety precaution

Thoroughly inspect the product and carefully read the related documentation to get acquainted with all the safety markings and instructions before you start to operate the Analyzer.

WARNING Only trained service personnel aware of the hazards involved should perform repair on the Analyzer.

CAUTION Tuning the Analyzer and replacement of the components that influence the accuracy of measurements without service personnel is strictly prohibited, since the components used in the Analyzer are purpose-made and their replacement will result in inaccurate operation of the Analyzer. To exclude the possibility of mechanical damage to the IT-12, the instructions regarding the storage and transportation (Sections 7 and 8) of the Analyzer must be observed.

2. GENERAL PRESCRIPTION AND PRINCIPLE OF OPERATION

2.1. Function

The IT-12 DVB-S/S2 Signal Analyzer allows positioning the antenna in the spectrum analysis mode, and performs measurements at a single point for one or two LNBS simultaneously. To simplify the alignment of a dish, audio indication mode can be implemented. IT-12 offers measurement of reception quality parameters: modulation error ratio MER, and bit error rate BER prior and after Viterbi/LDPC decoder. IT-12 features automatic defining of the settings (transponder frequency, symbol rate, FEC, polarization).

The IT-12 can be connected to a personal computer to access additional modes. The Analyzer also offers mode of constant voltage measurement at its input. The appearance of the Analyzer and its components is displayed in figures 2.1 and 2.2.



Figure 2.1

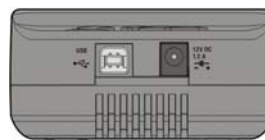

Figure 2.2

This Operating Manual is made in accordance with IT-12 software version 12.2.2.3 and ItToolsSatellite software version 1.6 for PC.

2.2. Environment Conditions

Normal operating conditions:

- a) ambient temperature $(23 \pm 5) \text{ }^\circ\text{C}$;
- b) relative air humidity $(55 \pm 25) \%$;
- c) atmospheric pressure 84-106 kPa (630-795 mm Hg);
- d) voltage transients correspond to installation category CAT. II.

Rated operating conditions:

- a) ambient temperature from -10 to $50 \text{ }^\circ\text{C}$;
- b) relative air humidity not greater than 90% at temperature $25 \text{ }^\circ\text{C}$;
- c) atmospheric pressure 84-106 kPa (630-795 mm Hg).

2.3. Package Contents

The Analyzer package includes:

- a) IT-12 DVB-S/S2 Signal Analyzer 1 pc;
- b) Rubber Boot..... 1 pc;
- c) Li-Ion Battery..... 1 pc;
- d) "F"-F Adapter..... 1 pc;
- e) Operating Manual 1 pc;
- f) PSU12/1.2 Mains Adapter 1 pc.

2.4. Specifications

Operating frequency range	950 to 2150 MHz
Frequency resolution	1 MHz
Input parameters:	
	a) input impedance within operating frequency range: 75 Ohm;
	b) allowed resulting value of AC and DC voltage at input for frequencies under 100 Hz: -2 ... 30 V.
Level measurement range	40 to 100 dB μ V
Measurement level resolution	0.1 dB
Accuracy within 40 – 100 dB μ V level range (at 23 °C).....	\pm 2.5 dB
Measurement channel passband for -3 dB level.....	10 to 65 MHz
Frequency indication.....	5 characters on LCD
Channel number indication	3 characters on LCD
Signal level indication	4 characters on LCD
Warm-up time	5 min
Input signal modulation	
DVB-S.....	QPSK
DVB-S2.....	QPSK, 8PSK
Symbol rate.....	1 to 45 Msps
FEC	1/2, 3/5, 2/3, 3/4, 4/5, 5/6, 7/8, 8/9, 9/10
LNB frequency error	\pm 10 MHz
MER measurement range	4 to 18 dB
BER measurement range prior to Viterbi decoder	10^{-5} to 10^{-1}
BER measurement range after Viterbi decoder	10^{-8} to 10^{-3}
BER measurement range prior to LDPC decoder.....	10^{-7} to 10^{-2}
BER measurement range after LDPC decoder.....	10^{-9} to 10^{-8}
Input DC voltage measurement range	3 to 30 V
LNB supply voltage.....	13, 18 V
LNB supply current	no less than 300 mA
LNB current consumption check range.....	50 to 350 mA
DiSEqC command system support	2.1 level
IT-12 Analyzer can be powered by	
- AC circuit with 85 to 265 V voltage, 50 to 60 Hz frequency with no more than 5% harmonic content, via PSU12/1.2 Mains Adapter;	
- external DC source with 9 to 14 V voltage, and no more than 0.5 V ripple;	
- internal Li-Ion batteries with capacity of at least 1500 mAh.	
Current consumed from external power source, not greater than.....	1.2 A
Continuous stable operation under normal conditions (when powered by external source).....	8 hours
Battery duration under normal conditions	
(1500 mAh battery capacity, LNB current 150 mA).....	1 hour
Mean time between failures, no less than.....	10000 hours
Average lifetime, no less than.....	5 years
Dimensions	193x94x53 mm
Package dimensions.....	255x180x70 mm

Weight..... 0.5 kg
 Weight in package 0.95 kg

2.5. Design and Operation Overview

2.5.1. Principle of Operation

IT-12 Analyzer is a DVB-S/S2 standard signal receiver with signal demodulation to MPEG-2 data stream. Modulation error ratio MER is measured during demodulation of the QPSK/8PSK signal based on vector analysis of the signals. Bit error rate BER in digital stream is determined by means of analysis of the operation of Viterbi/LDPC and Reed-Solomon/BCH decoders. The measurement of RF signal power level is performed by means of digital AGC system. The operation principle of the spectrum analyzer is based on the sequential analysis with spectrum indication either on the Analyzer LCD graphic screen or on the screen of the external PC.

2.5.2. Block Diagram

The block diagram of IT-12 Analyzer is shown in figure 2.5.1. Input signal is injected into the Tuner (TN), which is a heterodyne receiver with quadrature mixer of zero intermediate frequency (IF). The DVB-S/S2 signal demodulation, reception quality and signal level determination are performed by Demodulator (DM). As the data stream in MPEG-2 format exits the DM, it immediately enters the Data Stream Decoder (DSD), the purpose of which is separating of the identification data. Reference clock rate frequency formation required for the operation of the Tuner and Demodulator is produced in the Oscillator (OSC).

LNB Power Supply (LNB PSU) forms source voltage for satellite LNB that supports DiSEqC commands. Input signals of DiSEqC protocol are processed with the Receiver (RCV).

The Control Unit (CU) receives the user commands entered from the Keypad (KP), implements data conversion and its display on the LCD graphic screen, and also it supports communication with external PC.

The Flash memory (FLASH) stores all the calibration coefficients specified by the manufacturer, Data Logger records, and firmware utilities.

The Power Supply (PSU1) forms all the required voltages either from the batteries or from the external power source.

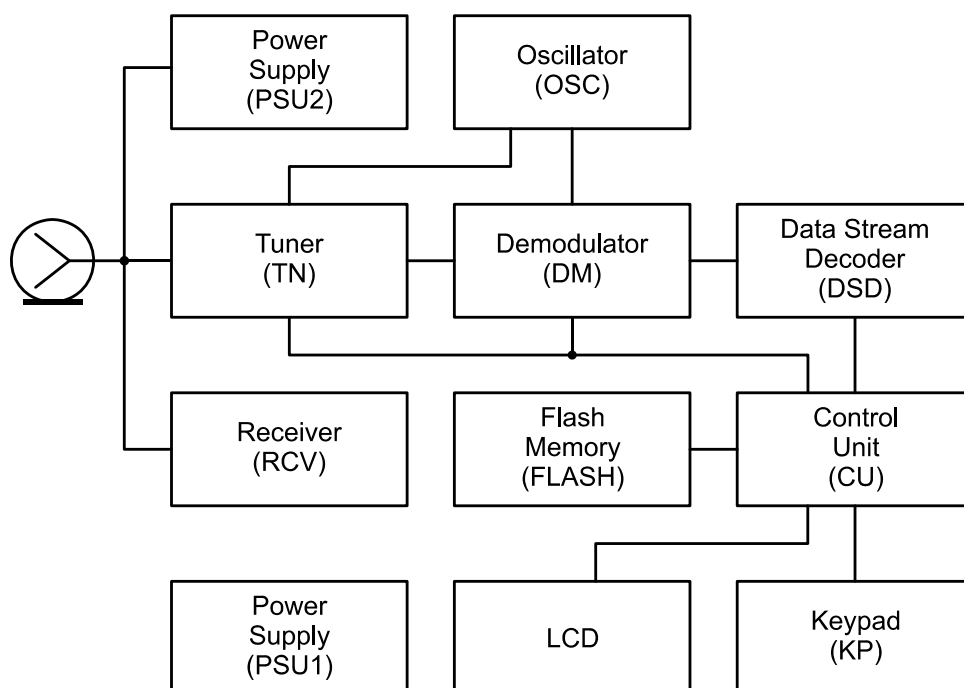

Figure 2.5.1

2.5.3. Component Arrangement

The IT-12 is implemented in plastic shockproof sectional housing that includes printed and three-dimensional wiring. IT-12 dimensions are 193x94x53 mm.

The front panel of the Analyzer represents the rubber keypad and graphical display (figure 2.1). The front panel has a USB connector and external power source connector (figure 2.2). The 75-Ohm input “F” male connector is located on the rear panel.

3. PREPARATION FOR OPERATION

Perform external examination to make sure your IT-12 is free from any visible mechanical damage.









Upon receipt of the package, check the availability of the items contained in it against the list provided (see section 2.3).

If the IT-12 has been kept in the environment other than the rated operating conditions, leave your Analyzer in facilities with normal operating conditions at least for 2 hours prior to operation.

4. OPERATION PROCEDURE

4.1. Controls and Indicators

The location of controls, indicators and connectors is shown in figures 2.1 and 2.2. These elements have the following functions:

- a) «F1», «F2», «F3» functional keys allow enabling the commands shown on the screen of the Analyzer;
- b) «» key allows returning to the previous menu level;
- c) «», «», «», and «» arrows allow editing the current operation mode;
- d) «» key enables the current option;
- e) «*» key allows accessing additional functions;
- f) «» key switches the Analyzer on/off;
- g) « 12V DC 1.2A» connector provides connection to an external power source;
- h) «» connector provides connection of the Analyzer to a PC;
- i) «**INPUT**» connector is for signal input, “F-male” type connector.

4.2. Operation Starting

Before you start to operate your IT-12 make sure to carefully read this Operating Manual as well as to inspect the location of the controls and indicators of the Analyzer (see section 4.1).

To prepare your Analyzer for operation from an external power source, connect the Mains Adapter to the connector located on the bottom of the IT-12 and then to the power source.

To prepare your IT-12 for operation in stand-alone mode, powered by the batteries, push and hold the «» key until the LCD backlight turns on.

The following message (see figure 4.2.1) will appear on the screen:

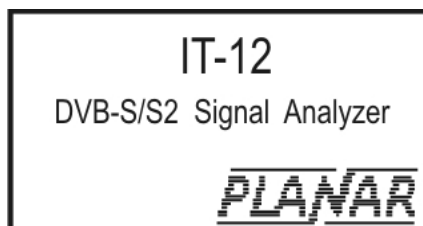

Figure 4.2.1

The screen displays the name and type of the Analyzer. After approximately 1 second, the Analyzer will open the main mode-selection menu – main menu (see figure 4.3.1) or the last previously operated mode before power was switched off.

4.3. Main Menu

All the operating modes of the Analyzer can be accessed through the menu system. There are three menus:

a) main menu (see figures 4.3.1);



Figure 4.3.1

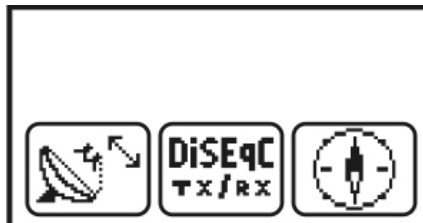



Figure 4.3.2

b) additional measurements menu (see figures 4.3.2), which you can access using the  icon in the main menu;

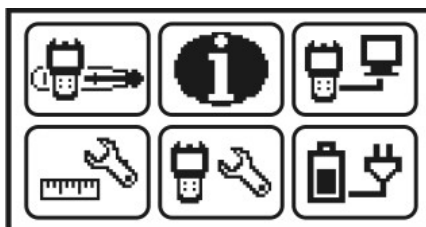



Figure 4.3.3

c) service menu (see figures 4.3.3), which you can access using the  icon in the main menu.

To select and enter any operating mode, proceed as follows: move the necessary icon to the bottom of the screen by «▲» and «▼» keys, and press one of the functional keys («F1», «F2», «F3»), which is under the required icon. Press «⬆» button to return to the main menu.

4.4. Preparation for Measurements

To make sure that the Analyzer is operating properly perform the procedure described below.

Select the row with the required parameter using «▲», «▼» keys in Analyzer settings mode , and set the following values by «◀» and «▶» keys:

- **Contrast:** 30%;
- **Display:** normal;
- **Language:** English; (Other option is Язык: русский);
- **Click:** type1;
- **Start:** menu.

Select the required parameters using «▲», «▼» keys in the Measurement settings mode



and then set the following values using «◀» and «▶» keys:

- **Averaging:** avr:1;
- **Peak level:** off.

Make sure that in the single LNB dish alignment mode , the input RF signal appears on the screen as shown in figure Single LNB Dish Alignment Mode

Press «⬆» key to return to the main menu.

4.5. Frequency Setting Modes

4.5.1. General Information

LNB profile tables are developed to make more convenient the IT-12 operation with a particular system containing a receiving satellite dish, one or two LNB converters, and the access system, e.g. DiSEqC switch, which provides the reception from a specific LNB. Such a table allows settings of LNB parameters, modes of polarization control and LO selection, and also LNB access mode. LNB profile memory allows saving of up to 50 pages with parameters.

The memory of the satellite profile tables is intended for quick setting of the Analyzer to the transponder frequency for the selected satellite within the current LNB profile. The table saves both satellite parameters (name, orbital position, broadcasting band) and the transponder parameters (frequency, polarization, symbol rate, FEC). The memory capacity allows saving of up to 99 satellite parameter tables. Each table can include up to 223 transponders.

4.5.2. Quick LNB Setting

In the process of operating the Analyzer and performing measurements the current LNB settings can be changed manually. Quick LNB setting mode is intended for implementing this operation. The  icon in the main menu corresponds to this mode. The mode allows performing quick setting operations of LNB parameters. See figure 4.5.1 for the representation of this mode.

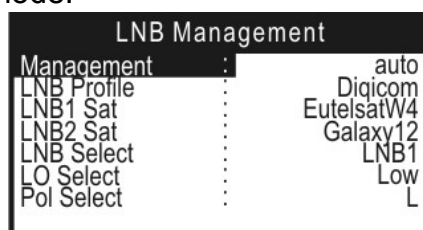

LNB Management	
Management	: auto
LNB Profile	: Diqicom
LNB1 Sat	: EutelsatW4
LNB2 Sat	: Galaxy12
LNB Select	: LNB1
LO Select	: Low
Pol Select	: L

Figure 4.5.1

Use «▲» and «▼» keys to select a parameter for editing. Parameter values can be changed by «◀» and «▶» keys. If **LNB Profile**, **LNB1 Sat**, **LNB2 Sat** parameters are highlighted, you can enter the table mode to select the required parameter by pressing «↓» or «F1» keys.

The table contains 7 parameters that are accessible for editing:

1. **Management** LNB management.

Available values:

- **off** - LNB is switched off, the power and control are not supplied;
- **manual** - LNB is switched on, LO and polarization are selected manually, according to this mode table;
- **auto** - LNB is switched on, parameters are set automatically according to transponders.

2. **LNB Profile** Selecting current LNB profile from the table of available profiles (section 4.5.3).

3. **LNB Select** Selecting the current LNB if it is not the only one in the profile.

4. **LNB1 Sat/ LNB2 Sat** The name of a satellite corresponding to LNB1/LNB2 from the satellite table (section 4.5.4).

5. **LO Select** Band switch on the LNB, if switchable within the current LNB.

Available values:

6. **Low/High** - low/high local oscillator.

7. **Pol. Select** Setting the polarization.

Available values:

- **Left/Right** - counterclockwise or clockwise circular polarization;
- **Hor/Vert** - horizontal or vertical linear polarization.

If the LNB control is switched off (**Management: off**), the voltage of power source and LNB control signal are not supplied. In this case **Local Oscillator** and **Polarization** parameters are not available for editing.

If the LNB management is switched to **manual**, then all the table parameters are available for editing. In this mode you should set the values for **LO** and **Polarization** manually according to the selected transponder parameters.

In the automatic control mode **LO** and **Polarization** parameters are unavailable for editing. The Analyzer automatically controls the parameters when tuning to a required transponder according to transponder parameters table.

In case the satellite has not been identified for the current LNB (**LNB1 Sat: none**), the tuning of the Analyzer in measurement modes can be performed only to frequency. Adjustments relative to transponder parameters are not available.

The power is supplied to LNB only after one of measurement modes has been selected. In all other modes LNB supply circuit is cut off.

4.5.3. LNB Profiles

You can enter this mode by pressing «↓» or «F1» keys when **LNB Profile** parameter is selected in LNB quick setting mode (see section 4.5.2). This mode allows executing all operations with LNB profile tables. The screen view is represented in figure 4.5.2.

No	LNB Profile Name
1	Digicom
2	Gardiner
3	*****empty*****
4	*****empty*****
5	*****empty*****
6	*****empty*****

At the bottom of the screen, there are three buttons: Edit, Sel, and Del.

Figure 4.5.2

The table upper row divides the screen into columns. The first column numbers the LNB profiles within the table. The second column contains the names of the profiles. The required profile (numbered from 1 to 50) can be selected by means of «▲» and «▼» arrows. The selected profile is highlighted. The second column contains the profile names of up to 12 characters in length, which are defined once a new profile is created, and which can be edited if necessary (in mode of operation with external PC). If the numbered row does not correspond to a profile, it is marked with *****empty***** message. The bottom line contains the list of commands that can be selected by means of the functional keys. LNB profile selected in quick LNB setting mode (section 4.5.2) or directly through the table using the **Sel** command will be highlighted with an inverse number display. Below is the list of the available commands:

- LNB profile parameters editing: **Edit**. Select using «F1» key. Allows reading and editing of the current profile parameters.
- LNB profile selection: **Sel**. Use «F2» key. Sets the current LNB profile as the default one for tuning to the specific transponder of the selected satellite.
- LNB profile deleting: **Del**. Select using «F3» key. Allows deleting a selected profile or clear all the LNB profile logs.

«↓» key can be used to select table scrolling mode: scroll one row up/down or scroll through the pages.

To edit LNB profile, locate the cursor at a required row and press «F1» key. The editing screen is shown in figure 4.5.3.

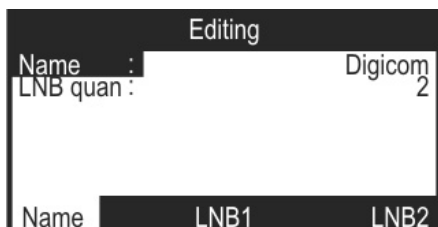

Figure 4.5.3

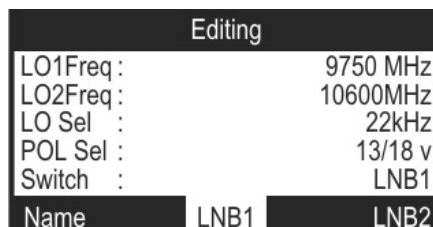

Figure 4.5.4

A profile parameters are organized on 2(3) tabs. To select a tab, press one of the functional keys («F1», «F2», «F3»).

The name of the parameter, selected for editing, is highlighted in the first column in inverted color. To select a specific parameter, use «▲» and «▼» arrows. The parameters are disposed in the following order:

The first tab contains general profile parameters:

- **Name:** Profile name. Name editing is available only during operation with external PC;
- **LNB quan:** Determines the number of LNBs per profile. The available values are 1 or 2. They can be set using «◀» or «▶» arrows.

The second tab (see figure 4.5.4) contains parameters of the first LNB1:

1. **LO1 Freq:** Frequency of the first local oscillator. Press «▶» arrow for editing, and enter the value of the frequency in MHz using «▲», «▼» and «◀», «▶» arrows. Press «↓» after the desired values have been entered.
2. **LO2 Freq:** Frequency of the second local oscillator. The setting of the parameter is the same as for the previous one.
3. **LO Sel.:** This parameter sets the method of switching between the LOs. Use «◀» and «▶» arrows to edit this parameter. The available values are the following:
 - **No** - one LO per LNB; In case the selected LO for the LNB is unchangeable (**LO Sel.: No**), then the frequency value of the second LNB cannot be edited and thus is not displayed on the screen;
 - **22kHz** - selection by modulation with 22 kHz frequency.
4. **DiSEqC** - selection by DiSEqC command.
5. **Pol. Sel.:** The parameter sets the method of switching the LNB polarization. Use «◀» and «▶» for editing. The available values for this parameter are the following:
 - **No** - polarization cannot be changed;
 - **13/18V** - selection by the power supply voltage.
6. **DiSEqC** - selection by DiSEqC command.
7. **Switch:** The parameter sets the method of accessing the LNB within a profile. If the LNB is connected through a switching unit (switch), then its input will be identified. Use «◀» and «▶» for editing. The available values for this parameter are the following:
 - **No** - no switching unit is used for LNB;
 - **LNB 1** - the LNB is connected to channel 1;
 - **LNB 2** - the LNB is connected to channel 2;
 - **LNB 3** - the LNB is connected to channel 3;
 - **LNB 4** - the LNB is connected to channel 4;
 - **LNB A** - the LNB is connected to channel A (Tone Burst switch);
 - **LNB B** - the LNB is connected to channel B (Tone Burst switch).

When you select parameter **LNB quan: 2**, a tab with the parameters of the second LNB becomes available. To select the tab, use «F3» key. The set of parameters is similar to the one for the first LNB.

4.5.4. Satellite Parameter Tables

You can enter this mode by pressing « \updownarrow » or «**F1**» keys when **LNB1 Sat.** or **LNB2 Sat.** parameters were selected in LNB quick setting mode (see section 4.5.2). This mode allows performing all operations with satellite parameters. The screen view is represented in the figure 4.5.5.

No	Satellite	Pos
1	EutelsatW4	36.0E
2	Galaxy12	124.0W
3	*****empty*****	
4	*****empty*****	
5	*****empty*****	
6	*****empty*****	

Buttons: Edit, Sel, Del

Figure 4.5.5

The table upper row divides the screen into columns. The first column numbers the satellites within the table. The second column contains the names of satellites. Third column contains the values of satellite orbital positions. The required satellite (numbered from 1 to 99) can be selected by means of « \blacktriangle » and « \blacktriangledown » arrows. The selected profile is highlighted. The second column contains the satellite names up to 12 characters in length, which are defined once a new profile is created, and which can be edited if necessary (in mode of operation with external PC). If the numbered row does not correspond to a satellite, it is marked with *****empty***** message. The bottom line contains the list of commands that can be selected by means of functional keys. The satellite with the selected LNB profile is highlighted in the table with its number in inverse color. If the corresponding LNB profile supports two converters, then two satellites need to be selected from the table according to each converter.

List of available commands:

- editing satellite parameters: **Edit**. Select using «**F1**» key. Allows reading and editing the current satellite parameters as well as adding a new satellite;
 - satellite selection: **Sel**. Select using «**F2**» key. Defines the satellite in accordance with the selected LNB profile and a specific converter (in case there is more than one). Quick LNB selection in this mode can be performed through LNB selection menu using «*****» key. Use « \blacktriangleleft » and « \blacktriangleright » arrows to select between **LNB1/LNB2**. This setting specifies the converter (first or second) which is defined for the satellite in the current LNB profile and does not influence the parameter **LNB Selection** in quick LNB setting mode (section 4.5.2). Use « \updownarrow » key to exit quick LNB selection menu;
 - deleting a satellite entry: **Del**. Select using «**F3**» key. Allows deleting a selected satellite entry or clear all the satellite profile logs.
- « \updownarrow » key can be used to select table navigation mode: scroll one row up/down or scroll through the pages.

To edit the satellite parameters, select the required field and press the «**F1**» key. To create a new satellite entry, highlight an empty row and press the «**F1**» key. The editing screen is represented in figure 4.5.6.

Editing	
Name	EutelsatW4
Position	36.0E
Band	Ku
Tr.qnt.	12
Update	26.03.07

Buttons: Scan, Tr

Figure 4.5.6

The table provides five parameters for a satellite:

- **Name:** Satellite name. Name editing is available only during operation with external PC;
- **Position:** Satellite orbital position value, 0 to 180 degrees of either Eastern (**E**) or Western (**W**) longitude;
- **Band:** Three values are available (**Ku**, **C** or **Ku/C**);
- **Tr. qnt.:** Number of transponders (up to 223), not editable;
- **Update:** The date of last update of the satellite entry or the date of creation of a new entry, not editable.

The bottom row of the screen displays two following commands:

- a) start scanning: **Scan**. Select using «**F1**» key. Allows searching transponders and then determining their parameters;
- b) editing the transponders table: **Tr**. Select using «**F3**» key. Enters the transponder parameters editing mode.

To determine the transponder frequency and other parameters automatically, press the «**F1**» key. The screen will display the scanning parameter setting table (figure 4.5.7).

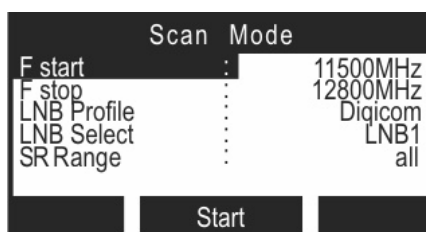

Figure 4.5.7

Before starting the scanning, consequently enter the start and stop frequencies of scanning in MHz. Specify the symbol rate searching range from the list below:

- **all** - For Low and High-speed transponders;
- **only HS** - For High-speed transponders.

Current LNB profile is selected from the list specified in the profile table. If one profile refers to two LNBs, it is required to specify which converter (**LNB1** or **LNB2**) is used for scanning.

The scanning procedure is activated by means of **Start** «**F2**» key and its status is indicated on the screen. To abort the procedure, press the «**↑**» key. Once the procedure is completed, the satellite parameter editing table will be displayed if at least one transponder has been identified (figure 4.5.8). Otherwise the Analyzer will return to initial scanning parameter setting mode (figure 4.5.7). Once the initial conditions have been corrected, the search of transponders can be repeated.

To correct the transponder table in the satellite parameter editing mode (figure 4.5.6), press **Tr** «**F3**». The transponder table will be displayed on the screen (figure 4.5.8).

N _o	Freq	P	SR	FEC
1	11727	L	27500	3/4
2	12111	L	26500	3/4
3	12175	L	4340	3/4
4	12270	R	27500	3/4
5	12226	L	27500	3/4
6	12245	R	27500	3/4
New		Edit		Del

Figure 4.5.8

The upper row of the table divides it into several columns. The first column contains transponders sequential numbers. The second column shows transponder frequency, in MHz. The third column indicates signal polarization type: **L/R** – left/right for circular polarization and **H/V** – horizontal/vertical for linear polarization. The fourth column shows symbol rate, in kSps. And the fifth column contains FEC value. Using «**▲**» and «**▼**» arrows

a transponder numbered up to 223 can be selected. The selected transponder will be highlighted. « \updownarrow » key can be used to select table navigation mode: scroll one row up/down or scroll through the pages. The bottom row contains the list of commands that can be selected using functional keys.

List of available commands:

- adding a new transponder: **New**. Select using «**F1**». Adds a new transponder to the table;
- editing transponder parameters: **Edit**. Select using «**F2**». Allows enabling transponder editing and automatic determination mode;
- deleting a transponder: **Del**. Select using «**F3**». Allows deleting the selected transponder.

Screen of the transponder editing mode is displayed in figure 4.5.9.

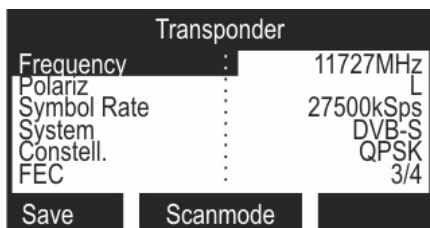

Figure 4.5.9

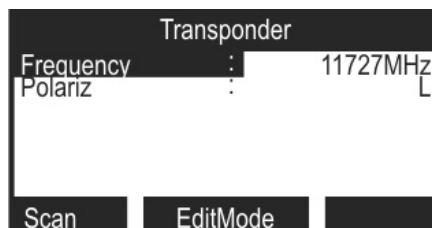



Figure 4.5.10

Select the parameter to be edited using « \blacktriangle » and « \blacktriangledown » arrows, and set the desired value using « \blacktriangleleft » and « \blacktriangleright » arrows. To save changes, press «**F1**». To quit the mode without saving, press « \updownarrow ».

To enable the transponder automatic determination mode within the transponder editing mode, select the required one and press «**F2**». A picture similar to transponder editing mode, except for commands in the bottom row, will appear on the screen (figure 4.5.10).

Set the initial data for parameter identification and press «**F1**». The progress of the procedure will be indicated on the screen. Once the process has successfully completed, the values of particular parameters, which can be saved with «**F1**» key, will be displayed on the screen. If the parameters have not been identified, the IT-12 will return to automatic parameter identification. Press «**F2**» key to return to transponder editing mode.

4.5.5. DiSEqC Commander Mode

The  icon in the service menu refers to this mode. This mode allows sending/receiving arbitrary DiSEqC commands. In this mode, the Analyzer runs as DiSEqC master device. The screen view is represented in figure 4.5.11. Rx: line shows the response of the slave device, and Tx: line shows the command of the master device.

The bytes of the master device commands and the slave device responses are grouped according to functions they fulfill. The description of the groups is given in the following table.

1. **FR** Sync byte, shows data transfer direction.
The possible values are:
 - E0...E3 – command from master device;
 - E4...E7 – response from slave device.
2. **AD** Address byte.
3. **CM** Command code byte.
4. **D0 – D2** Data bytes.

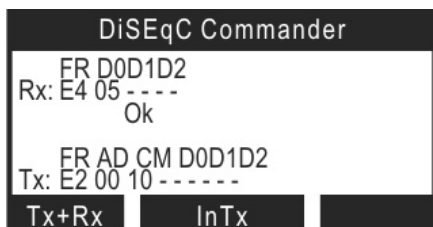

Figure 4.5.11

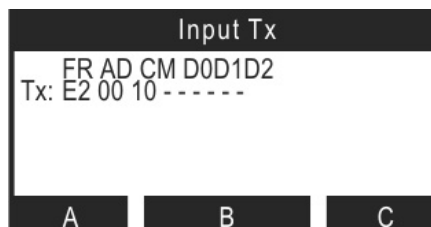

Figure 4.5.12

A specific message will help you to understand the slave device response. It appears under **Rx:** line after the response reception. The following messages are supported:

Message Text	Description
Ok, no errors	Slave device successfully accepted the command;
Not supported	Slave device does not support the command;
Parity error	Slave device received the command with an error, the command should be repeated;
Not recognized	Slave device does not recognize the command, it should be repeated.

The bottom row of the screen in the main window of this mode displays the functions of «F1» and «F2» functional keys. When you press «F1» key, the master device sends a command to the slave device, and then receives a response from the latter. To enter the command input mode (see figure 4.5.12), press «F2» key. Command bytes are entered in hexadecimal representation (code). Use «◀» and «▶» arrows to select position for command entering. Characters from A to F are entered by «F1» - «F3» functional keys, to change character entering mode from A – C to D – F, press «*» key. Use «▲», «▼» arrows to select the characters from 0 to F in the entering position. Press «⏪» key to exit the mode.



DiSEqC commands can be sent only if LNB management parameter in quick LNB setting mode (section 4.5.2) is set to **manual** or **auto** values. When you exit DiSEqC commander mode, LNB power supply is switched off in 1 minute in order to prevent the DiSEqC slave device resetting. If in the process of operating the Analyzer you enter and then exit DiSEqC commander mode, after this the following rule will be enabled and active till next power off/on: every time you exit any measurement mode an automatic delay of 20 seconds will be provided to allow LNB power to turn off.

Note! If the parameters in the LNB profile are managed by DiSEqC commands, these commands will be performed when you enter any measurement mode.

4.6. Measurement Procedure

4.6.1. General information

The IT-12 supports 5 measurement modes:

- a) Single LNB Dish Alignment..... ;
- a.1) Spectrum Analyzer «F3»;
- a.2) Table of Reception Quality Parameters «F2»;
- b) Dual LNB Dish Alignment ;
- c) Dish Alignment to Reception Quality Parameters ... .

Modes a), c) are available in the main menu (figures 4.3.1). To enter a.1) or a.2) modes from  mode, use «F3» or «F2» respectively. Modes b) are available in the additional measurements menu (figures 4.3.2).

4.6.2. Measurement Parameter Setting Mode

The  icon in the Analyzer settings mode refers to this mode. In this mode the screen displays the list of parameters (figure 4.6.1), which define the measurement settings.

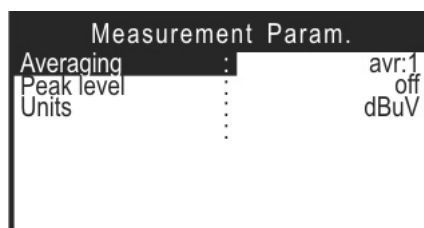



Figure 4.6.1

Use «▲» and «▼» keys to select the required parameter. Edit the required values by means of «◀» and «▶» arrows.

The following three parameters are available for editing:

1. **Averaging:** Selection of the measured data averaging type. This parameter adjusts the measured signal level calculation scheme.
The values available:
 - **avr:1** - the measured level value is displayed immediately;
 - **avr:4** - the displayed value is the average of four measurement results;
 - **avr:8** - the displayed value is the average of eight measurement results.
2. **Peak level:** Activating the logging of the peak level in spectrum analyzer and dish alignment modes. The highest measured signal level during the measurement time is displayed in spectrum analysis diagram or signal level indicator. The peak level can be cleared using «*» key. The available values are **on** (switched on) and **off** (switched off).
3. **Units:** Selection of level measurement units. The parameter changes the units in which the measured level is displayed: **dBuV** or **dBm**.

4.6.3. Single LNB Dish Alignment Mode

The  icon in the main menu corresponds to this mode. When operating in this mode, RF signal level in a particular frequency point is displayed on the screen. See figure 4.6.2.

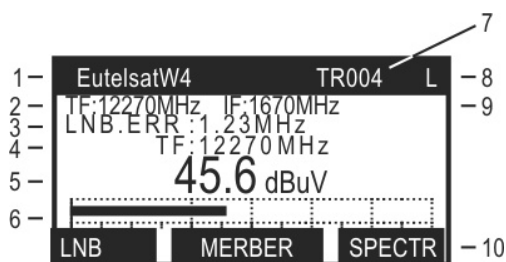

Figure 4.6.2

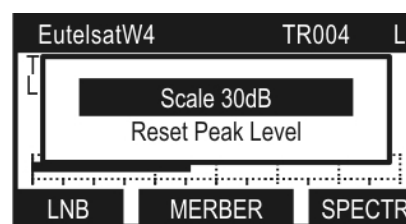

Figure 4.6.3

Index 1 is the satellite name selected from the satellite table (section 4.5.4). Index 2 represents the frequency value at LNB input (**TF**), which is the frequency of transponder, number of which is indicated by index 7 (**TR**). The frequency value at the input of the Analyzer is marked by index 9 (**IF**).

When the synchronization with the input signal is achieved, it is indicated with **L** (lock) symbol in position indexed 8, and the mode heading line starts blinking.

If the synchronization has not been achieved, the **U** (unlock) symbol is displayed. In synchronization mode the Analyzer measures and displays the error of setting of the LNB heterodyne frequency, which is displayed in position with index 3. The measured level is

displayed either in digital (index 5) or graphical (index 6) form. One of the following scales can be used to display measurement level in graphical form: **30 dB Scale** – minimum displayed level is the signal level at Analyzer input at the moment of selection confirmation, and maximum level is the minimum +30 dB; **Full Scale** – minimum and maximum levels according to the specifications (section 2.4). The scale can be selected in the menu (figure 4.6.3) using «◀» and «▶» arrows. Use «⏎» key to confirm your selection. Press «*» button to call out the menu. The RF signal level can be displayed either in dB starting from 1 microvolt (**dBuV**), or in dB starting from 1 milliwatt (**dBm**). The displayed units can be switched in measurement parameter setting mode (section 4.6.2). The current frequency value is also shown by index 4. It indicates the parameter, which defines the frequency value. It can either be signal frequency at the LNB input (**TF**), signal frequency at the Analyzer input (**IF**), or satellite transponder number (**TR**) set in the corresponding table. Changing the parameter value is performed using «◀» and «▶» arrows. Use «⏎» key to switch between the change modes: change by 1 / change by 10. Selection of parameter is performed by «▲» and «▼» arrows. Selection of setting parameters depends on **Management** parameter that has been set in the quick LNB setting mode (section 4.5.2). In case **Peak level** parameter in the measurement parameter table (section 4.6.2) is set to **on**, then index 6 will display two values for signal level: dark column shows the current level value, and transparent column shows the maximum level value achieved during the measurement. To reset peak level, press «*» button in the menu that will appear (figure 4.6.3), select Reset Peak Level using «▲» and «▼» arrows and press «⏎». Functional keys commands are displayed in position with index 10.

To fine tune or change the current mode settings, you can use the supplementary LNB settings table. Press «F1» to open the table. See figure 4.6.4.

LNB Settings	
LNB Select	LNB1
LO Select	Low
Polariz	L
Symbol Rate	27500kSps
Constl FEC	QPSK 3/4
Frequency	11730 MHz
LNB Current	18V/115 mA

Figure 4.6.4

The upper three rows of the table display the LNB parameters: the current converter from LNB profile, LO, and polarization. These parameters are available for editing, their description is given in section 4.5.2. The following two rows display symbol rate, type of modulation and FEC. **Symbol Rate** parameter is also available for editing. In the next row current frequency value is displayed. The bottom row displays voltage at Analyzer input and consumption current by LNB. **Constl.FEC**, **Frequency** and **LNB Current** parameters cannot be edited.

If the **Symbol Rate** parameter is highlighted, the symbol rate from the satellite parameter table (section 4.5.4) will be displayed as its value. If the **Symbol Rate** parameter is not highlighted, the current value will be displayed.

After the LNB settings table is closed, the **Symbol Rate** parameter retains its value until you switch to another transponder or exit the measurement mode.

Single LNB dish alignment mode allows quick switching to other measurement modes with saved frequency settings:

- a) press «F2» to enter reception quality parameter table mode (section 4.6.7);
- b) press «F3» to enter spectrum analyzer mode (section 4.6.5).

If selected LNB profile, satellite, LNB control mode are not correct or the entered transponder frequency is wrong, then the following message will appear on the screen (figure 4.6.5). In this case measurements are not performed. To resume measurements it is necessary to perform the following:

- a) verify that parameter values of the current LNB are correct;

- b) verify that the selected satellite profile corresponds to the type of the selected LNB;
- c) ensure that LNB control parameter is set to **auto** value (when using satellite profile);
- d) verify that frequency value or LO are selected correctly.

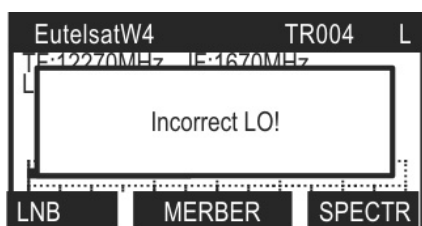

Figure 4.6.5

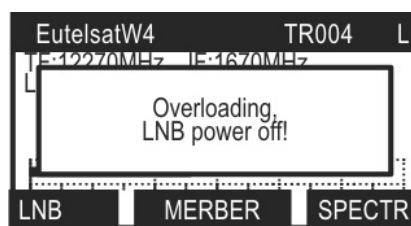

Figure 4.6.6

If maximum limit of consumption current by LNB is exceeded, then the following message appears on the screen (figure 4.6.6) and LNB powered is turned off. LNB power will restore after you re-enter this mode.

4.6.4. Dual LNB Dish Alignment Mode



The icon in the additional measurements menu corresponds to this mode. When using this mode, two signal levels from two LNBs are displayed simultaneously on the screen. See figure 4.6.7:

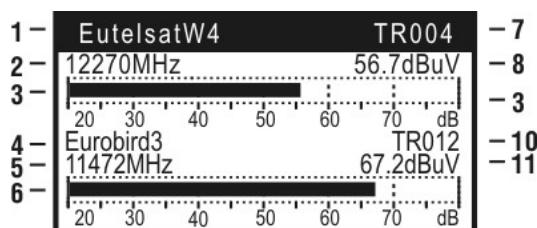

Figure 4.6.7

Indices 1 and 4 show the names of satellites that have been selected in the satellite table (section 4.5.4). Positions with indices 2 and 5 indicate the frequency values for LNB input (TF), i.e. frequencies of the transponders, numbers of which are displayed in indices 7 and 10 (TR). The measured levels are displayed in digital (8 and 11 indices) or graphical (3 and 6 indices) form. The RF signal levels can be displayed either in dB starting from 1 microvolt (**dBuV**), or in dB starting from 1 milliwatt (**dBm**). The displayed units can be switched in measurement parameter setting mode (section 4.6.2). Adjustment according to frequency in this mode is implemented in accordance with the satellite transponder number, which corresponds to the current table settings. Changing the transponder number value is performed by «**◀**» and «**▶**» arrows. The LNB, according to which the setting is done, can be selected by «**▲**» and «**▼**» arrows. The selected LNB is indicated by highlighting the satellite name and transponder number.

To activate the supplementary table, press «**F1**». See figure 4.6.4 for the representation of the table. When you open LNB settings table from this mode, the table will show the settings for the selected LNB. The settings will not be available for editing.

Operations in this measurement mode can be performed only under the following conditions:

- a) the LNB profile has been edited for operation with two LNBs. If this condition is not fulfilled, the following message appears on the screen (figure 4.6.8).

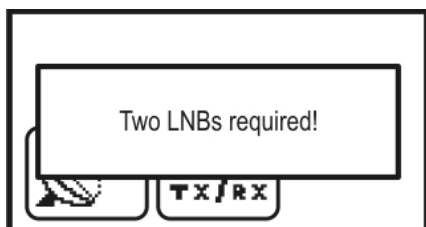

Figure 4.6.8

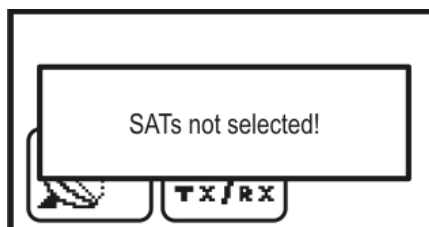



Figure 4.6.9

b) a satellite is defined for each LNB. If this condition is not fulfilled, the following message appears on the screen (figure 4.6.9).

4.6.5. Spectrum Analyzer Mode

To enter the mode from the single LNB dish alignment mode , use «F3» key. The purpose of this mode is to display the RF signal spectrum with 1200 MHz band, i.e. the whole IF of satellite spectrum on the screen. Figure 4.6.10 shows the view of the screen:

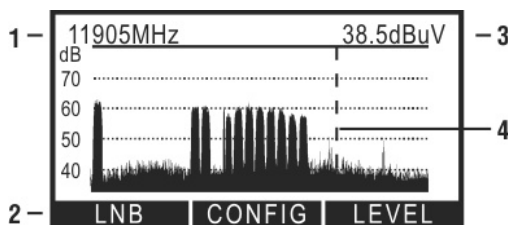

Figure 4.6.10

Index 3 displays the level of the RF signal in a particular frequency point (the frequency value is shown in position indexed 1), to which the marker (position with index 4) points. The marker is a broken vertical line. Assignment of the functional keys is presented in the bottom row (index 2).

Shifting the marker is performed by «◀» and «▶» arrows.

To fine tune or change the LNB parameters you can use LNB setting parameter table. To access this table press «F1». The view of the table is represented in figure 4.6.11.

LNB Settings		
LNB Select	:	LNB1
LO Select	:	Low
Pol.Select	:	L
LNB Current	:	18V/115 mA

Figure 4.6.11

LNB settings are described below:

- **LNB select:** Selection of the current LNB, if there are more than one LNBS in the profile;
- **LO select:** Selection of the local oscillator;
- **Pol. select:** Selection of polarization;
- **LNB current** Voltage at the Analyzer input and LNB consumption current.

Press «↑» or «F1» keys to exit this table.

Use «▲» and «▼» keys in the spectrum analyzer mode to adjust one of the representation parameters in the spectrum settings table. Press «F2» key to enter this table (figure 4.6.12).

Spectrum Settings	
Scale	20 dB
Ref.level	-100dBm
Show IF	no
Show grid	yes

Figure 4.6.12

The parameters in the spectrum settings table have the following functions:

1. **Scale:** Amplitude scale. The values available are: 5, 10, 20 dB/scale division.
2. **Ref. level:** Amplitude reference level position. Auto **value** corresponds to automatic reference level adjustment by the Analyzer.
3. **Show IF:** The possible values are:
yes – show the intermediate frequency in position indexed 1 (figure 4.6.10);
no – show the frequency of the satellite range;
4. **Show grid:** The possible values are:
yes – show the grid;
no – hide the grid;

To work with a particular parameter, select one using «▲» and «▼» arrows. The parameter can be altered using «◀» and «▶» arrows.

Additional parameters of the mode setting are provided in measurement parameter setting mode (section 4.6.2):

- a) Peak level display. If this parameter has been activated (on value), then the spectrum analyzer screen displays the current spectrum diagram along with the highest signal levels achieved at every frequency point during the entire measurement (the line above the main diagram). The peak line can be cleared manually using the «*» key;
- b) Selection of level display units. The value of the level is displayed either in dB starting from 1 microvolt (**dBuV**), or in dB starting from 1 milliwatt (**dBm**).

You can use «F3» key for quick switching to single LNB dish alignment mode (section 4.6.2).

Rated error of level measurement cannot be guaranteed in this mode, as it is intended for evaluation of input signal level value.

4.6.6. Dish Alignment to Reception Quality Parameters Mode

The  icon in the main menu corresponds to this mode. In this mode two parameters featuring the reception quality are displayed simultaneously on the screen. Screen view is shown in figure 4.6.13.

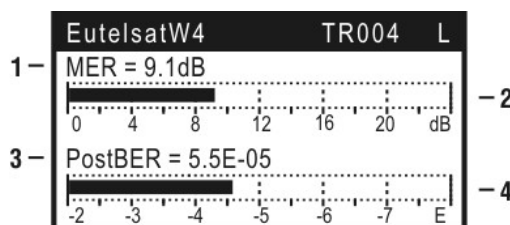



Figure 4.6.13

The top row displays the following settings: satellite name selected from the satellite table (section 4.5.4), transponder number and synchronization indicator (**L**-lock or **U**-unlock). During synchronization the heading is flashing. Each reception quality parameter is represented both in digital (indices 1 and 3) and in graphical (indices 2 and 4) forms.

You can select the reception quality parameters to be simultaneously displayed in the mode setting table. Press «F2» key to access this table. You can select two parameters to

be simultaneously displayed out of the following available ones: **PreBER**, **PostBER**, **MER**, **Level**. You can set **30 dB Scale/Full Scale** (section 4.6.3) for **Level** value of first indicator. The value of **Level** parameter indicates the signal level at the set frequency as in dish alignment mode with one LNB (section 4.6.2).

For any parameter displayed by the upper indicator (in positions indexed 1 and 2)

you can enable «aural detection» function by setting **Sound check** to **on** in  mode. The audio tone in this case is generated only when synchronization with the signal is achieved (synchronization indicator is **L**-lock).

While synchronization is unavailable (synchronization indicator is **U**-unlock) you will see «---» characters instead of numeric values in positions with indices 1 and 3, and minimum values of the corresponding parameters displayed by the graphical indicators (indices 2 and 4). When synchronization is achieved you will see the **PreBER** and **PostBER** values in 1 to 10 sec., **MER** and **Level** values will be indicated immediately. During this time you will see the creeping line of «-» characters instead of numeric values indicating that measurement is in process.

The frequency adjustment in this mode is performed in accordance with the transponder number of the satellite set in the corresponding table. You can change the transponder number by «◀» and «▶» keys. Use «↓» key to switch between the change modes: change by 1 / change by 10.

To fine tune or change mode settings you can use LNB setting parameter table. To access this table press «F1». The view of the table is represented in figure 4.6.4. The settings are described in section 4.6.3.

Press «F3» key to enter the reception quality parameter table mode (section 4.6.7) with saved frequency settings.

Operation in this measurement mode can be performed only if satellite profile has been selected. If this condition is not fulfilled, the following message appears on the screen (figure 4.6.14).

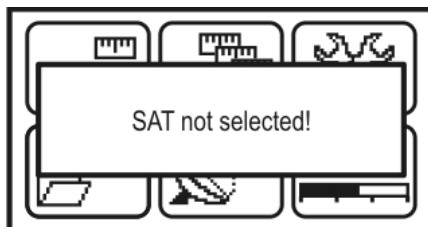



Figure 4.6.14

4.6.7. Reception Quality Parameter Table Mode

To enter the mode from the single LNB dish alignment mode  use «F2» key. In this mode the table of parameters characterizing the input signal quality and identification data is displayed on the screen. The screen view is shown in figure 4.6.15.

HotBird	TR004	L
PreBER	:	1.2E-2
PostBER	:	5.5E-5 PASS
MER	:	9.1 dB
RealErr	:	0
Netw.Name	:	CYFRA+
Orb.Posit	:	13.0°E
Constl	Channel	Save

Figure 4.6.15

The top row displays the following settings: name of the satellite selected from the satellite table (see section 4.5.4), transponder number, and the synchronization indicator (**L**-lock or **U**-unlock). During synchronization the heading is flashing. The following three rows display the parameter values: bit error rate (**BER**) in the digital stream before

Viterbi/LDPC decoder (**PreBER**), after Viterbi/LDPC decoder (**PostBER**), and modulation error ratio (**MER**). **PostBER** value will be indicated depending on achievement of the threshold value of $2 \cdot 10^{-4}$ (for DVB-S transponders). If the value is under the threshold you will see **PASS** (acceptable value) message, otherwise you will see **FAIL** message.

Modulation error ratio (**MER**) corresponds to signal-noise ratio at the receiver input and allows estimating the capability of the receiver to decode the signal without errors. MER is measured in dB and allows estimating the signal/noise ratio margin to decode the satellite signal without errors.

BER parameter before Viterbi/LDPC decoder, like MER, characterizes the quality of the input signal and shows the probability of errors in the input data stream. The parameter update rate is 1 to 10 sec. The main parameter, that determines the reception quality of the satellite signal, is BER after the Viterbi/LDPC decoder. The threshold value of this parameter is $2 \cdot 10^{-4}$ (for DVB-S transponders). If BER value is under the threshold, the output error probability (at the Reed-Solomon/BCH decoder output) is within the range of $10^{-10} \dots 10^{-11}$. Such error probability provides the stream that is quasi-free from errors and thus ensures a steady television reception. The parameter is updated every 8 seconds. If the parameter attains the value of **>2.0E-03**, it is the evidence of unrecoverable data blocks after Reed-Solomon/BCH decoder. The quantity of error blocks is presented by **RealErr** parameter. Press «*» key to reset the **RealErr** parameter value.

The identification data rows **Netw.Name** and **Orb.Posit** display the information separated from the traffic stream, which indicates the tuning to the required satellite. The **Netw.Name** row contains ETSI registered network name. The **Orb.Posit** row indicates the orbital position of the satellite.

To adjust the desired transponder number, use «◀» and «▶» keys. Use «↓» key to switch between the change modes: change by 1/change by 10. After the synchronization has been achieved, the first row will show **L** symbol, and after the time which the measurement takes, the parameter values will appear on the screen.

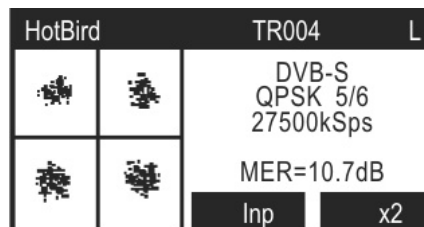

Figure 4.6.16

To view the constellation diagram (figure 4.6.16), use «F1» (**Constl**) key. The display mode of the vector diagram of demodulated signal with basic parameters will appear on the screen.

To select a quadrant, which will be displayed as a contour line on the diagram, use «▲» and «▼» keys. Press «F3» to zoom in. Only selected quadrant will be displayed on the screen. Press «F3» again to zoom out. «F2» key selects the mode of constellation diagram display: select «Inp» for constellation diagram at the demodulator input and «Dmd» for constellation diagram at the demodulator output. To reset the constellation diagram, press «*».

To return to the table mode of reception quality parameters, use «F1» or «↑».

To save the measured values in the data logs, press «F3» (**Save**). The confirmation dialogue will appear on the screen. Press «F1» to proceed or «F3» to abort. Further, the table of reports containing reception quality parameters will appear on the screen (section 4.7.2). The new page can either be saved to the offered free location or can be manually saved to a desired location, whether it is free or not. After you have selected the row, press «F2» key to save the data or «↑» to exit the table without saving. Page name can also be changed in mode of operation with external PC.

To view the list of the transponder channels, press «F2» (**Channel**). «Loading...» message will appear on the screen, what indicates the start of the channel data detection in the traffic flow. Maximum downloading time is up to 3.5 min. When the download is complete, the channel table window will appear on the screen (figure 4.6.17). The channel table can contain up to 30 channel records. If a channel record does not appear in the table, this shows that there are no this channel data in the traffic flow. Pressing «↑» while the downloading is in the process will stop it and the channel table will appear on the screen (figure 4.6.17) if some data have already been detected, or the Analyzer will return to the reception quality parameter table (figure 4.6.15).

No	Ch. Name	S	R	A
1	Movies24	V	R	+
2	4fun.TV	V	R	-
3	Orange Sport	V	R	-
4	Planète	V	R	+
5	MINIMINI	V	R	+
6	PATIO TV	V	R	-

View

Figure 4.6.17

Channel Parameters	
Name :	Movies
Serv. :	dig.television
Status :	running
CA :	yes
V-PID :	0161
A-PID :	0085

Figure 4.6.18

The upper row divides the table into the following columns:

1. **No** Number in the table.
2. **Name** Channel name.
3. **S** Service type. The following values are available:
 - «V» - TV channel;
 - «A» - radio channel;
 - «D» - data;
 - «r» - reserved service;
 - «-» - service type undetermined.
4. **R** Status. The following values are available:
 - «R» - unning;
 - «N» - not running;
 - «r» - reserved service;
 - «-» - service status undetermined.
5. **A** Conditional access. The following values are available:
 - «-» - access is not conditional;
 - «+» - access may be conditional.

Use «▲» and «▼» arrows to scroll through the pages. Use «↓» key to select the scrolling mode: scroll by rows, or scroll by pages.

To view the required channel page, select this channel by «▲» and «▼» arrows and press «F1» (**View**). The table of the channel parameters will appear on the screen (figure 4.6.18).

Channel parameters in the table are as follows:

1. **Name:** Channel name.
2. **Serv.:** Service type. The following values are available:
 - **dig. television** - TV channel;
 - **digital radio** - radio channel;
 - **data broadcast** - data;
 - **reserved** - reserved service;
 - **undetermined** - service type undetermined.
3. **Status:** Status. The following values are available:
 - **running** - running;
 - **not running** - not running;
 - **reserved** - reserved service;
 - **undetermined** - service status undetermined.
4. **CA:** Conditional access. The following values are available:
 - **no** - access is not conditional;

- **yes** - access may be conditional.

5. **V-PID**: Video packet ID;

6. **A-PID**: Audio packet ID.

4.6.8. Recommended Procedure for Satellite Dish Alignment

This section describes the process of satellite dish alignment by means of IT-12 DVB-S/S2 Signal Analyzer. This description, however, is a recommendation and is mainly intended to make the user familiar with the operation principles of the Analyzer during the initial use.

The preparation for satellite dish alignment can be subdivided into several key steps:

The first step shall be preparing the satellite parameter table and the LNB parameter table. At this stage it is more preferable to operate the Analyzer via external PC. Such operation will facilitate initial use and can make easier future stand-alone operation of the Analyzer. In case there is no external PC, all the preparatory works can be performed without it.

Preparations during operation with external PC:

After performing all the recommendations given in the sections 4.11.1 through 4.11.5, create (copy from local directory) the required LNB types in the LNB profiles mode in LNB Profile Logs mode. Be sure that you select an active profile. Then create tables of satellites which will be further used for operation in Satellite Profile Logs mode. Some tables can be found at <http://www.planar.chel.ru> in the Related Files section on the page describing IT-12 DVB-S/S2 Signal Analyzer. After selecting the satellite for LNB the preparations are finished.

Preparations during stand-alone operation:

Select the required mode of operation with the satellite parameter tables (section 4.5.4). If the table does not contain a satellite, with which the operation is planned, select an empty row and press «**F1**» key (editing). The satellite name, orbital position value, and range shall be left as by default. Enter the parameters of the known transponders such as frequency, polarization, symbol rate, system, constellation and FEC (auto selection can be used - **auto**) into the transponders table («**F3**»).

Select the LNB profiles mode (section 4.5.3). If the table does not contain the profile prepared for operation, select an empty row and press «**F1**» key (editing). Enter the values in the profile parameters table according to table provided below or your own values. Profile name shall be left as by default. Typical «universal» LNB parameters are the following:

- **LNB quan.:** 1;
- **LO1 Freq:** 9750 MHz;
- **LO2 Freq:** 10600 MHz;
- **LO sel.:** 22 kHz;
- **Pol. sel.:** 13/18 v;
- **Switch:** no.

The second step shall be setting the Analyzer to perform measurements according to prepared satellite and LNB profile tables. To do this, select the quick LNB setting mode (see section 4.5.2). In the table set the automatic LNB control parameter. Select the prepared LNB profile and satellite. The parameters in **LNB Select** and **LNB2 Sat** rows will be unavailable for alteration since the current profile has only one LNB. **LO Select** and **Pol. Select** parameters are also unavailable for editing since the automatic selection mode is switched on for these parameters.

After completing the above steps, the Analyzer is ready for operation with the selected satellite and LNB profile.

To position the dish, connect the output of the LNB mounted on the dish to the IT-12 input using a stub cable. Set the following parameter values in the measurement parameter setting mode (see section 4.6.2):

- **Averaging:** avr:1
- **Peak level:** On

Turn on the spectrum analyzer mode (section 4.6.5). Activate the table of parameters group «F2». Set the amplitude scale to 5dB/Division. Press the « \uparrow » key. The RF signal spectrum will appear on the screen. Fine tune the dish position in the direction that will make the satellite signal visible over the noise. Tuning of the dish shall be slow enough to allow it to adjust to the spectrum sweep velocity. Use « \leftarrow » and « \rightarrow » arrows to place the marker to the supposed location of transponder signal and enter single LNB dish alignment mode (section 4.6.3) by pressing «F3» key. Tune to any particular transponder using « \leftarrow » and « \rightarrow » arrows. Perform a careful dish tuning according to the strongest signal. The highest achieved level of the signal is displayed on the screen as a clear bar. When signal level reaches the sufficient value for demodulator synchronization, header row will start flashing, position 8 on the screen will display L symbol, signifying the synchronization and the beginning of MPEG stream decoding.

Press «F2» key to enter reception quality parameter table (section 4.6.7). Control **PostBER** parameter values with different transponders. Its value must not exceed 2.0E-04, which means that the signal quality is sufficient for receiving the satellite signal. The 2.0E-04 value is the threshold value for bit error rate (for DVB-S transponders). To provide a strong reception of signal, PostBER value must be less than 1.0E-07, which means that there is approximately a 2 dB margin for C/N parameter (for DVB-S transponders). Note that the PostBER parameter measurement period is approximately 8 seconds. PostBER parameter for transponders with the lowest signal level with both polarizations must be checked.

To identify the satellite check the network name and orbital position, after which the tuning process is completed.

4.7. Data Logger Function

4.7.1. General Information

Data Logger function is intended for automation of the procedure of recording the measurement results. There are three data logger directories: LNB profile table, satellite parameters table, and reception quality parameters logs. The memory capacity allows saving up to 50 LNB profiles (section 4.5.3), up to 99 pages of satellite parameters, each containing up to 223 transponders (section 4.5.4), up to 100 pages of reception quality parameters logs. The Analyzer allows viewing the data saved off-line or using the PC.

4.7.2. Table of Reception Quality Parameters Reports

The  icon in the main menu corresponds to this mode. The mode allows performing all possible operations with reception quality parameter logs: viewing, deleting, and clearing all the pages. See figures 4.7.1 and 4.7.2 for representation of this mode:

N _o	Page Name
1	Kotina-231
2	Lenina-6
3	*****empty*****
4	*****empty*****
5	*****empty*****
6	*****empty*****

View Del

Figure 4.7.1

Lenina-6		
Level	:	-36.7dBm
PreBER	:	1.2E-2
PostBER	:	5.5E-5 PASS
MER	:	9.1 dB
Net.Name	:	NTV Plus
Orb.Posit	:	36.0°E

Exit TrInfo

Figure 4.7.2

The table with data logs will appear on the screen (figure 4.7.1). The upper row divides the table into columns. The first column contains numbers of pages from 1 to 100. The second column contains the page names. Use « \blacktriangle » and « \blacktriangledown » arrows to scroll through the pages. Use « \downarrow » key to select the scrolling mode: scroll by rows, or scroll by pages.

List of available commands:

- a) viewing the page (**View**). Select by «F1» key. Allows viewing the required page (figure 4.7.2). Button (**TrInfo**) allows viewing the parameters of the transponder on which the measurement was done;
- b) deleting the page (**Del**). Select by «F3» key. Allows deleting the selected page or all the pages from the IT-12 memory.

To delete a page (or all pages) from the logs, select the required one and press «F3» key. A confirmation dialogue box will appear on the screen. To confirm the deleting, press «F3» key. To cancel the deleting, press «F1» key. To clear all pages, press «F2» key.

4.8. Self-Test Mode

4.8.1. General Information

Self-test mode is provided for checking the performance of IT-12 components and their functional condition. The  icon corresponds to this mode in Analyzer settings menu. See figure 4.8.1 for the representation of the screen in this mode:

Self Test		
Temperature :	+24 °C	Ok
Batt. voltage :	7.40V	Ok
Batt. capacity :	100%	
Batt. temp. :	+24 °C	Ok
Devices :		Ok
Files mem :	87% free	
Calib.table :		Ok

Figure 4.8.1

The table displays the following parameters to be checked:

- a) **Temperature**. Temperature inside the Analyzer;
- b) **Batt. voltage**. Voltage of the battery;
- c) **Batt. capacity**. The remaining capacity of the battery;
- d) **Batt. temp**. Temperature of the battery;
- e) **Devices**. Condition of the Analyzer components;
- f) **Files mem**. Data logger memory resources;
- g) **Calib.table**. Condition of calibration coefficient tables.

4.8.2. Temperature

The parameter is intended for checking the temperature inside the Analyzer. Temperature is the main environmental factor, which influences the accuracy of measurements. To check the accuracy of measurements of the signal level, use the temperature parameter. If the temperature value is within the allowed range, then **Ok** status will be displayed in the end of the value line. If the temperature is beyond this allowed range, then status will not be displayed. If instead of temperature value “---” is displayed, this indicates the defect of the temperature measuring device. In this case please apply to the service center.

The Analyzer is equipped with a fan to reduce the internal temperature in case of high ambient temperature. Compulsory ventilation is automatically switched on if the temperature inside the Analyzer is above 50°C, and if temperature decreases down to 45°C, the ventilation will be switched off. If temperature inside the Analyzer rises above the maximum allowed value, the operation of the Analyzer will be suspended, LNB supply voltage will be turned off, and the following warning will appear on the screen (see figure 4.8.2).

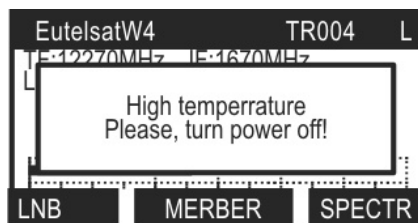

Figure 4.8.2

4.8.3. Battery Condition

Batt. Voltage, Batt. Capacity, and Batt. Temp. parameters are intended for checking the battery condition. Check the battery condition when operating in stand-alone mode (power supply switched off). If the measured battery voltage is greater than 7.4 V, then **Ok** status is indicated. If the voltage is less than 7.4 V, then **Low** status is indicated. The voltage will then be recalculated into the remaining battery capacity value in percent, which will help you to estimate the time remaining for the Analyzer to operate. You should consider that with decrease of air temperature the battery capacity also decreases. This should be taken into account when estimating the operating time of the Analyzer. If the temperature of the battery rises above the maximum allowed value, charging process is automatically stopped.

4.8.4. Internal Devices Check

This program checks the condition of the Analyzer components. If an error has been detected, failed component name appears for the short time, and then an **Error** status is displayed. In this case the Analyzer must be sent to service center to have the defects corrected.

4.8.5. Memory Resources Check

This program determines the remaining resources (in percent) of the memory of all the types.

4.9. User Interface Setting

4.9.1. General Information

The user interface setting program is intended for modifying the general parameters of the Analyzer operation. The  icon corresponds to this mode in the service menu. See figure 4.9.1:

Analyzer Settings		
Contrast	:	30%
Display	:	normal
Language	:	english
Sound check	:	off
Click	:	off
Sound level	:	5%
Start	:	last

Figure 4.9.1

The following parameters are available for editing:

- Contrast.** LCD contrast setting;
- Display.** Display mode selection;
- Language.** Language setting;
- Sound check.** Audio indication switch setting;
- Click.** Key pressing sound setting;
- Sound level.** Sound level setting;
- Start.** Startup mode setting.

You can select the parameters using «▲» and «▼» arrows. The parameter value is changed by «◀» and «▶» keys.

4.9.2. LCD Contrast Setting

The screen contrast can change with time or with the change in the ambient temperature. To tune the contrast, select the corresponding parameter and tune the value using «◀» and «▶» keys. The possible range is from 0 to 100% with 10% step. The set value will be saved and will be valid after you turn the Analyzer on again.

4.9.3. Displaying Mode Selection

There are two available values of this parameter: **normal** - regular display, and **reverse** - display in inverse colors.

4.9.4. Language Selection

There are two options for the parameter available: **english**, **русский**, all the messages are displayed in the corresponding languages. All the values of the physical quantities are always displayed in English in all the measurement modes.

4.9.5. Audio Indication Mode

There are 3 values of the parameter available: **alwaysOn** - signal level measurement «by audio indication», **aftrLock** - the tone is switched on after the synchronization with the input signal and **off** - the tone is switched off. You can change the parameter by «◀» and «▶» keys. This function is available in the Measurement modes, Dish alignment mode (see section 4.6.3) and Dish alignment to reception quality parameter mode (see section 4.6.6).

4.9.6. Key Pressing Sound Selection

There are 2 options for the sound: **off/type1**.

4.9.7. Sound Level Setting

The range of possible values: 5...100%.

4.9.8. Startup Mode Selection

There are two options for the parameter available: **menu** – Analyzer starts operation from the main menu (figure 4.3.1) after you turn the Analyzer on, **last** – Analyzer starts the operation from the last previously operated mode, before the Analyzer was turned off.

4.10. Identification Data Readout

Identification data readout mode shows the serial number of the Analyzer, its modification and software version. The  icon of the service menu corresponds to this mode. See figure 4.10.1:

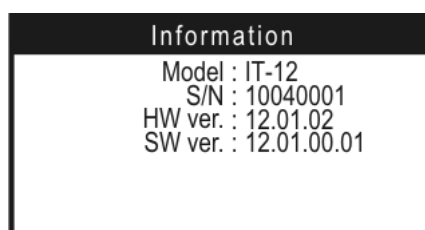

Figure 4.10.1

The upper part of the screen displays the identification information of the IT-12:

- **Model:** the Analyzer model;
- **S/N:** the Analyzer serial number;
- **HW ver.:** number of the hardware version;
- **SW ver.:** number of installed software version.

4.11. Operation Controlled by PC

4.11.1. General Information

You can control operation of your IT-12 DVB-S/S2 Signal Analyzer via PC. For connection to PC use **USB** connector on the front panel of your Analyzer. The software ItToolsSatellite 1.6 is available at our website <http://www.planar.chel.ru>. The software allows the following:

- measurement of satellite signal level and other parameters;
- viewing the RF signal spectrum at the Analyzer input;
- viewing the constellation diagram;
- viewing the list of transponder channels;
- viewing and editing the satellite lists;
- viewing and editing the LNB profile logs;
- viewing and editing of the measurement logs of the input signal quality parameters;
- saving and management of the local copies of the satellite lists and logs of the Analyzer;
- saving and documenting the measurement results;
- firmware updating (only IT-12).

4.11.2. PC Configuration Requirements

Minimal system requirements for your PC:

- a) Microsoft Windows 7/Vista/XP/2000 operating system;
- b) 6 MB of hard drive free space (15 MB while installation);
- c) free USB 2.0 port.

4.11.3. Software Installation

The installation of the required software is executed by «**Install ItToolsSatellite X_X_X.exe**» program (X_X_X – software version), which performs all the actions necessary for saving program to the computer.

Before installation, close all active applications. If you use Windows 2000 or XP, to proceed with installation you should log in with administrator rights.

After you have started the installation program the installation wizard window will appear. Choose the program language and click «**OK**» to confirm your choice. Click «**Next**» to initialize installation.

Enter the user information into the corresponding fields. For Windows XP, Windows 2000 it is possible to select installation either for all users or solely for the current user. Click «**Next**» when you have completed all the fields.

Next, select the folder where you want to store ItToolsSatellite program files. By default, the files are stored into «**C:\Program Files\PLANAR\ItToolsSatellite**». To save the files in a different folder, click «**Browse**» button. Select the required path and click «**OK**».

Next window shows all the entered information. If you wish to proceed with the installation, click «**Next**». To return to previous steps and modify any information, click «**Back**».

The following steps will be completed automatically. If everything ran correctly, the information window indicating the successful installation will be displayed on the screen. Click «**Finish**» to complete the installation.

After the installation is complete, a new folder named «**PLANAR**» will be created in the «**Start**» menu, and this folder will contain a shortcut for accessing «**ItToolsSatellite**» program.

When reinstalling or updating the program, it is recommended to delete the older program version. To do this, «**Install ItToolsSatellite X_X_X.exe**» file must be activated; in case the program had already been installed, select «**Delete program**» option in the

dialog window and click «Next» button, which will initialize correct process of deleting the program from your PC and provide notification about successful completing of the task. New installation procedure is the same as the one described above.

ATTENTION It is not recommended to delete files from the program catalogue yourself, since it may lead to further incorrect operation of the program. To delete the program, use a corresponding mode within the installation wizard.

4.11.4. USB Port Driver Installation

Connect the Analyzer to your PC using USB cable and turn the Analyzer power on.

Enter the PC Operation mode by selecting the  icon in the Analyzer service menu. The **Waiting for command** message will appear in the top line of the screen. After that the new device installation wizard will start.

Perform the installation manually indicating the following path to the driver: ".\\Planar\\ItToolsSatellite\\Drivers".

After the installation has been completed a new device indicated as **IT-12 DVB-S/S2 Signal Analyzer** will appear in Device Manager (see figure 4.11.1).

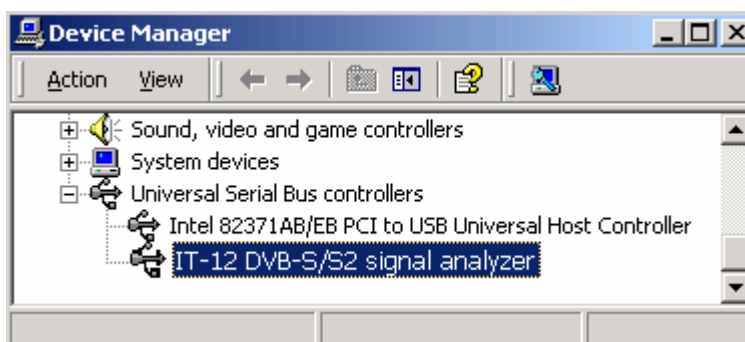



Figure 4.11.1

4.11.5. Starting the Program

Use one of the following ways to run ItToolsSatellite software:

- from the Start button menu: choose Start->All programs->PLANAR->ItToolsSatellite;
- from the desktop: choose ItToolsSatellite label.

ATTENTION Before you start the program, make sure that your Analyzer is connected to the computer correctly, the power is switched on, and the Analyzer is in PC connection mode .

4.12. Firmware updating

To perform IT-12 firmware update, select  icon on the control panel. Firmware updating manager window will appear (figure 4.12.1).

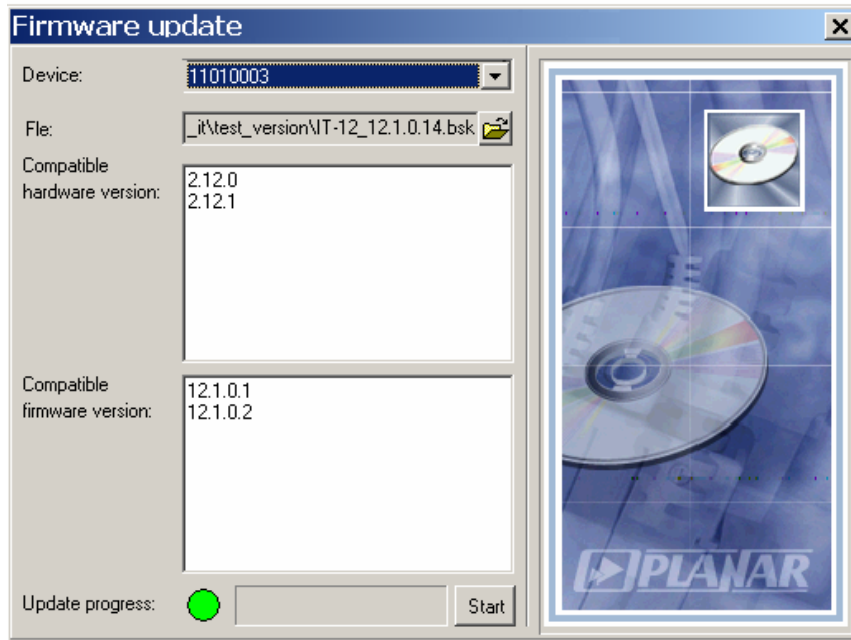



Figure 4.12.1

Firmware updating manager window includes the following elements:

- list of devices. You can choose one of devices from the list by their serial numbers;
- full file name. You can select a file for downloading by clicking  button. In the standard dialog window for file opening, select the required file with *.bsk extension;
- list of device's hardware versions, which are compatible with the selected update file;
- list of device's firmware versions, which are compatible with the selected update file;
- update progress indicator and «**Start**» button.

To update device's firmware, perform the following steps: select the device, select the firmware file, click «**Start**» button, and follow the step-by-step instructions, which will appear on the screen during updating.

If your Analyzer functions properly, USB port cable connected correctly and the firmware updating file is compatible with IT-12, the process of program updating onto your Analyzer will automatically start. **The Analyzer must be powered from an external power source.** After the download is over the pop-up window will announce that the operation has been successfully completed. The IT-12 will reboot and start operating similar to when it has been powered up.

CAUTION Do not interrupt the firmware uploading process. This can lead to malfunction of the Analyzer. But, if this does occur, turn the Analyzer power off. Then turn the Analyzer on again while holding down the «**F2**» key. The **IT-12 Bootloader** window will appear on the screen of the Analyzer. Repeat the firmware updating process.

After rebooting the following message (figure 4.12.2) can appear on the screen informing about the data stream decoder (DSD) software updating (section 2.5.2). Please wait until the updating process is completed and do not power the Analyzer off. After updating is completed you can go on with the Analyzer operation.

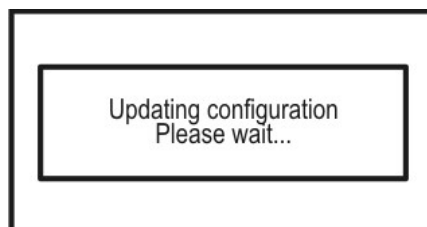



Figure 4.12.2

4.13. Battery Operation

The IT-12 is powered by a built-in power source with original Li-Ion battery with 7.4 V voltage and 1500 mAh capacity.

To determine the residual capacity of the batteries, use the self-test program of the Analyzer (section 4.8). When the effective charge level of the battery drops to a critical point (6.8 V) you will hear a warning beep. This signifies that the time of operation until total battery discharge is a few minutes.

To charge the batteries without removing them from the Analyzer, connect your instrument to an external 12 V DC power source or to a car cigarette lighter socket of 12 V. The Analyzer will turn on.

The provided charging mode allows a full charge of the batteries in 4 hours. You can control the charging process by the charging manager program. The  icon in the Analyzer settings menu refers to this program. The screen view of this manager program you can see in figure 4.13.1:

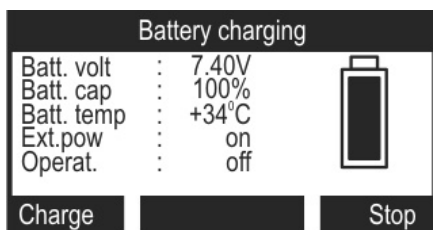

Figure 4.13.1

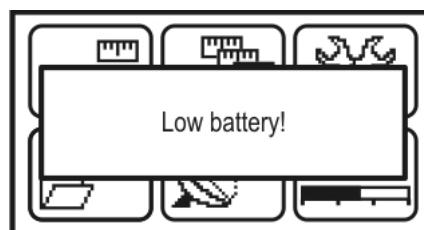

Figure 4.13.2

The following parameters are displayed on the screen:

- Batt.voltage** - voltage of batteries;
- Batt.capacity** - residual battery capacity;
- Batt.temp** - temperature of the battery;
- Ext.pow** - presence of external powering. If the Analyzer is powered by an external source, **on** status will be displayed;
- Operat.** - The active charging mode.

The following values are available:

Off – charging is off; and **On** – charging process in on.

When the battery is absent, the dashes are shown for **Batt. volt** and **Batt. cap** parameters.

The bottom row contains the list of commands that can be selected using the functional keys. To start charging, press «**F1**». To stop the process, press «**F3**».

As soon as IT-12 is connected to an external power source, the process of charging starts immediately. In this mode the charging current will be 0.6 A. Charging may continue up to 4 hours, depending on the initial level of battery charge. When this period of time is over the process will stop. If voltage becomes less than 8.02 V, charging process will be resumed.

If you need to charge the batteries fully, start the charging manager and activate the charging mode by pressing «**F1**» key.

The circuit design of battery charge provides automatic current cut-off if the resultant battery voltage is more than 8.5 V. You can check the voltage of the batteries using the IT-12 self-test program (section 4.8).

If voltage decreases below 6.6 V, the following warning will appear on the screen (see figure 4.13.2). In this case LNB will be powered off immediately, and the Analyzer will be powered off in 20 seconds.

4.14. Magnetic Compass Mode

The  icon in the additional measurements menu corresponds to this mode (figure 4.3.2). You will see this icon only if your Analyzer is equipped with built-in magnetic compass. This mode allows determining the direction to a satellite. The main screen of this mode is represented in figure 4.14.1.

Indices 1(6), 2(7) and 3(8) indicate the LNB number and satellite graphic symbol, orbital position of the satellite to which the LNB is aligned, and the LNB polarization angle (for LNBS with linear polarization), respectively. The graphic symbols (index 9) representing satellites are shown on the line (index 4), which represents the position of the satellites available over horizon in the location of the measurement. The current pointing of the Analyzer is represented by the blinking crosshair cursor (index 10), azimuth (AZ) value and elevation angle (EL) value (index 5). Commands of functional keys are indexed 11.

If a satellite to which one of the LNBS is aligned is not available in the location of the measurement its LNB number (index 1 and 6) will be displayed as a blinking label and its graphic symbol will not be shown on the line of the line of the available satellites (index 4).

If the graphic symbol of the satellite is covered with the cursor this means that the input connector of the Analyzer is pointed directly to the satellite.

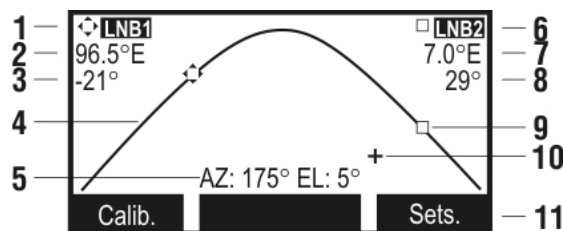

Figure 4.14.1

The current measurement location can be set in the table of settings. This table can be accessed by «F3» (**Sets**) key. The table is shown in figure 4.14.2.

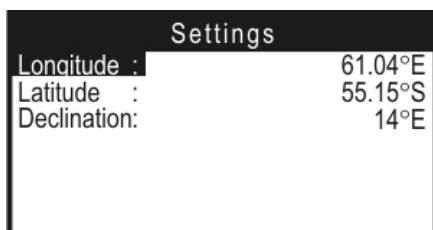

Figure 4.14.2

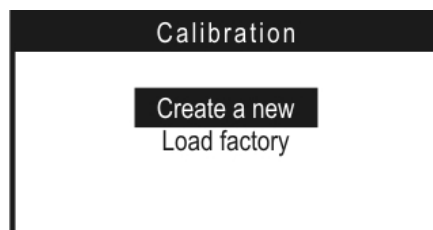

Figure 4.14.3

Settings available:

- **Longitude:** Geographical longitude of the current Analyzer location;
- **Latitude:** Geographical latitude of the current Analyzer location;
- **Declination:** Declination of the current Analyzer location.

Use «▲» and «▼» keys to scroll to the required parameter. Then enter editing mode by means of «◀» and «▶» arrows and set the required values by «▲» / «▼» and «◀» / «▶» keys. Use «⏪» key to exit editing without saving changes, or use «⏩» to exit editing saving the new values.

The Declination parameter is the angle between geographic and magnetic meridians. It is unique for each place on the globe. Also this parameter is variable with time and requires adjustment. The value of this parameter for a specific location can be found e.g. at <http://www.ngdc.noaa.gov>. Use «**↑**» or «**F3**» to exit the table of settings.

Use «**F1**» (**Calib.**) to enter magnetic compass calibration mode. Calibration mode performs calibration to make the performance of the compass more accurate. The screen of this mode is shown in figure 4.14.3. Two commands are available in this mode: create a new calibration (described in section 4.14.1), and download of factory (initial) calibration. The downloaded factory calibration will be effective till the Analyzer is switched off or a new calibration is created. Use «**↑**» to exit the calibration mode.

4.14.1. Magnetic Compass Calibration

Perform magnetic compass calibration in the location of the measurement (or near it) for the Analyzer to use the geographical features of the Earth magnetic field intensity. To start calibration select «**Create new**». The calibration will be executed in three steps:

- a) calibration along X axis (figure 4.14.4);
- b) calibration along Y axis;
- c) calibration along Z axis (figure 4.14.5).

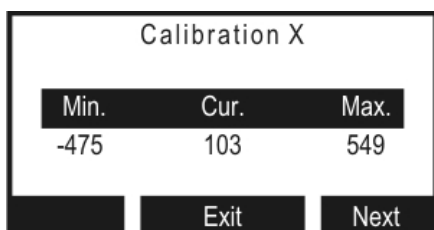

Figure 4.14.4

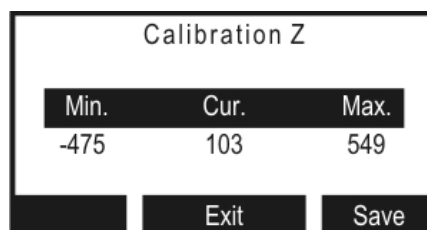

Figure 4.14.5

During each step of calibration smoothly turn the Analyzer in all directions to find the minimum (**Min.** in figure 4.14.4) and the maximum (**Max.** in figure 4.14.4) values of projection of the Earth magnetic field lines along each axis. The current value of the projection is shown under **Cur.** Switching to the following step of the calibration is performed by «**F3**» (**Next**) key. Use «**F3**» (**Save**) key in Z axis calibration to save the changes, exit calibration, and open the main screen of the magnetic compass (figure 4.14.1). Use «**↑**» or «**F2**» to exit the calibration mode.

The saved calibration will be downloaded each time you open the magnetic compass mode. Incorrect or incomplete calibration will lead to high error in azimuth value determination.

To check if the calibration was performed correctly slowly turn the Analyzer in horizontal plane watching if the azimuth value changes smoothly (index 5 in figure 4.14.1) from 0° to 360°. If the value changes abruptly, repeat the calibration or download the factory calibration. To achieve higher accuracy of the compass performance we recommend performing measurements after setting the measurement mode according to instructions in section 2.4.

Note! Environmental metal objects and magnet fields of other devices distort the Earth magnetic field and influence the magnetic compass performance up to complete disorder. To maintain accurate performance of the magnetic compass we recommend to repeat the calibration at least once a year.

4.14.2. Recommended Procedure of Magnetic Compass

Select the required satellite for one (or each) LNB in the table of satellite settings (section 4.5.4). Check if the orbital position of the satellite is specified correctly, as this value is used in magnet compass computing. Use  icon to enter the magnet compass mode. Check if the location in the table of settings is specified correctly (figure 4.14.2).

Calibrate the magnet compass if necessary (4.14.3) or use factory calibration. Then, you can start determining the direction to the satellite. Lift up the upper part of the Analyzer (with the input connector) to the level when the blinking cursor will be on one horizontal line on the screen with the graphic symbol of the satellite shown on the satellite line. After that, keeping this “uplifted” position move the Analyzer to the right (or left) till you cover the graphic symbol by the blinking cursor. In this position the input connector of the Analyzer points directly to the satellite.

5. MAINTENANCE

Required maintenance is limited to observation of instructions related to proper operation, storage, and shipment, which are supplied in this Manual and also minor defects correction.

Perform preventive inspections covering check of controls, reliability of the assembly, and the keypad condition after the warranty period has expired and annually since then.

6. TROUBLESHOOTING

Defect detection: The IT-12 fails to turn on in stand-alone mode.

Possible reason: Extremely low charge, malfunction, or improper installation or missing of one or more of the batteries.

Methods of correction: To check the IT-12 condition, connect the Mains Adapter. If the Analyzer switches on, check the battery voltage in self-test mode (section 4.8). Low voltage (under 6.6 V) is an evidence that one or more batteries are discharged or damaged. Voltage that is higher than normal (over 8.5 V) indicates that one or more batteries are malfunctioning or missing. The batteries should be charged in case they are low (section 4.13) or replaced if they are malfunctioning.

Possible reason: Firmware failure.

Methods of correction: Install the firmware from your computer (section 4.12).

Defect detection: The IT-12 fails to turn on in stand-alone mode, but the LCD backlight is on.

Possible reason: The program has “frozen”.

Methods of correction: Push and hold the «**U**» key for 5 seconds. The Analyzer will turn off. Then release the key and turn the IT-12 on again.

Defect detection: High error at level measurements.

Possible reason: Increased wear of the RF input adapter.

Method of correction: Replace the input adapter by the proper one.

7. STORAGE

Store your IT-12 under the following conditions: environment temperature from -20 to +50⁰C, relative humidity up to 90 % (at 30⁰C).

8. TRANSPORTATION

The IT-12 must be shipped in any closed vehicle at temperature from -20 to +50⁰C, relative humidity 90% (at 30⁰C) and atmospheric pressure of 84 to 106.7 kPa (630 to 800 mm Hg).

Cargo holds, railway cars, containers, and truck beds, utilized for shipment of the IT-12 should be free from any traces of cement, coal, chemicals, etc. When shipped by air the products should be kept in aircraft sealed compartments.

9. LABELING

The serial numbers of Analyzer, which contain index number and date-of-manufacture code, can be found on the bottom panel of the respective item and also can be viewed on the display in identification data readout program (section 4.10).

10. WARRANTY INFORMATION

The manufacturer warrants the IT-12 DVB-S/S2 Signal Analyzer to conform to the specifications of this Manual when used in accordance with the regulations of operation detailed in this Manual.

The manufacturer will repair or replace without charge, at its option, any IT-12 DVB-S/S2 Signal Analyzer found defective in manufacture within the warranty period, which is twelve (12) months from the date of purchase. Should the user fail to submit the warranty card appropriately certified by the seller with its stamp and date of purchase the warranty period will be determined by the date of manufacture.

The warranty is considered void if:

- a) the defect or damage is caused by improper storage, misuse, neglect, inadequate maintenance, or accident;
- b) the product is tampered with, modified or repaired by an unauthorized party;
- c) the product's seals are tampered with;
- d) the product has mechanical damage.

The batteries are not included or covered by this warranty.

Transport risks and costs to and from the manufacturer or the authorized service centers are sustained by the buyer.

The manufacturer is not liable for direct or indirect damage of any kind to people or goods caused by the use of the product and/or suspension of use due to eventual repairs.

When returning the faulty product please include the accurate details of this product and clear description of the fault. The manufacturer reserves the right to check the product in its laboratories to verify the foundation of the claim.